

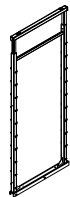

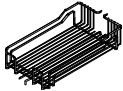

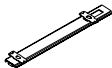



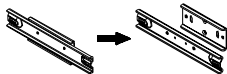

MODEL			W-5000 W-5400	W-5500	W-5600
Pos/Poz	DRW/RYS	Part name / nazwa czesci	Qty/Ilosc	Qty/Ilosc	Qty/Ilosc
1		Frame / Rama	1		
2		Basket / Kosz	4	5	6
3		Upper slide / Prowadnica gorna	1		
4		Lower slide with cover Prowadnica dolna z oslonami	1		
5		Mounting front / Mocowanie frontu	3	4	4
6		Screw M6 L = 10mm - head with spherical Wkret M6 L=10mm z lbem z kulistym	10		
7		Button head $\varnothing 4,2$ L=16mm self-tapping screw Wkret $\varnothing 4,2$ L=16mm z lbem z podkladka	4		
8		Button head $\varnothing 4,2$ L=19mm self-tapping screw Wkret $\varnothing 4,2$ L=19mm z lbem z podkladka	18		
9		Flat head screw M6 L=10mm Wkret M6 L=10mm z lbem stożkowym	2		
10		Flat head screw M5 L=10mm Wkret M5 L=10mm z lbem stożkowym	8		
11		Hex socket set screw with flat point M6 L=6mm Wkret dociskowy imbusowy M6 L=6mm - płaski	8		
12		Hex socket set screw with cone point M6 L=16mm Wkret dociskowy imbusowy M6 L=16mm - stożek	2		
13		Allen key 3mm / Klucz imbusowy 3mm	1		



	Model				D	L
	Cargo MIDI	Cargo MAXI				
W-5000-300	W-5400-300	W-5500-300	W-5600-300	500	250	
W-5000-400	W-5400-400	W-5500-400	W-5600-400	500	350	
W-5000-500	W-5400-500	W-5500-500	W-5600-500	500	450	
W-5000-600	W-5400-600	W-5500-600	W-5600-600	500	550	
H min	1210	1410	1710	1910		
H max	1410	1710	1910	2110		

REMARKS / UWAGI:

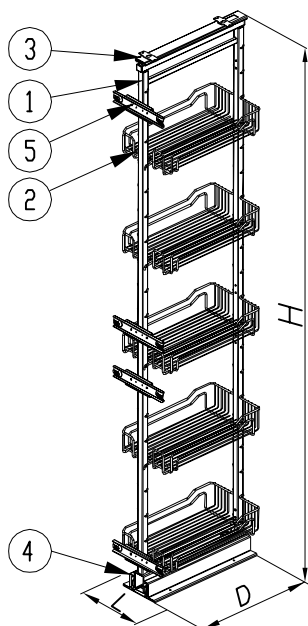
Max capacity / maksymalne dociazenie systemu - 120kg